

2803 THRU 2824

HIGH-VOLTAGE, HIGH-CURRENT DARLINGTON ARRAYS

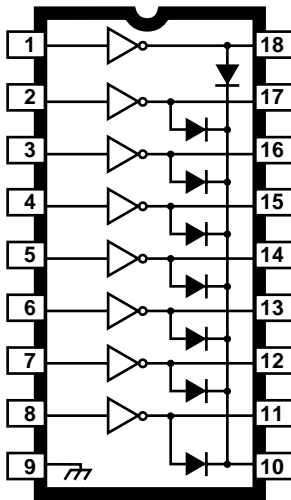

Dwg. No. A-10,322A

Note that the ULx28xxA series (dual in-line package) and ULx28xxLW series (small-outline IC package) are electrically identical and share a common terminal number assignment.

ABSOLUTE MAXIMUM RATINGS

Output Voltage, V_{CE}	
(x2803x and x2804x)	50 V
(x2823x and x2824x)	95 V
Input Voltage, V_{IN}	30 V
Continuous Output Current, I_C	500 mA
Continuous Input Current, I_{IN}	25 mA
Power Dissipation, P_D	
(one Darlington pair)	1.0 W
(total package)	See Graph
Operating Temperature Range, T_A	
Prefix 'ULN'	-20°C to +85°C
Prefix 'ULQ'	-40°C to +85°C
Storage Temperature Range,	
T_S	-55°C to +150°C

Featuring continuous load current ratings to 500 mA for each of the drivers, the Series ULN28xxA/LW and ULQ28xxA/LW high-voltage, high-current Darlington arrays are ideally suited for interfacing between low-level logic circuitry and multiple peripheral power loads. Typical power loads totaling over 260 W (350 mA x 8, 95 V) can be controlled at an appropriate duty cycle depending on ambient temperature and number of drivers turned on simultaneously. Typical loads include relays, solenoids, stepping motors, magnetic print hammers, multiplexed LED and incandescent displays, and heaters. All devices feature open-collector outputs with integral clamp diodes.

The ULx2803A, ULx2803LW, ULx2823A, and ULN2823LW have series input resistors selected for operation directly with 5 V TTL or CMOS. These devices will handle numerous interface needs — particularly those beyond the capabilities of standard logic buffers.

The ULx2804A, ULx2804LW, ULx2824A, and ULN2824LW have series input resistors for operation directly from 6 V to 15 V CMOS or PMOS logic outputs.

The ULx2803A/LW and ULx2804A/LW are the standard Darlington arrays. The outputs are capable of sinking 500 mA and will withstand at least 50 V in the off state. Outputs may be paralleled for higher load current capability. The ULx2823A/LW and ULx2824A/LW will withstand 95 V in the off state.

These Darlington arrays are furnished in 18-pin dual in-line plastic packages (suffix 'A') or 18-lead small-outline plastic packages (suffix 'LW'). All devices are pinned with outputs opposite inputs to facilitate ease of circuit board layout. Prefix 'ULN' devices are rated for operation over the temperature range of -20°C to +85°C; prefix 'ULQ' devices are rated for operation to -40°C.

FEATURES

- TTL, DTL, PMOS, or CMOS Compatible Inputs
- Output Current to 500 mA
- Output Voltage to 95 V
- Transient-Protected Outputs
- Dual In-Line Package or Wide-Body Small-Outline Package

**The ULx2804, ULx2823, & ULx2824 are last-time buy.
Orders accepted until October 19, 2001.**

x = Character to identify specific device. Characteristic shown applies to family of devices with remaining digits as shown. See matrix on next page.

2803 THRU 2824 HIGH-VOLTAGE, HIGH-CURRENT DARLINGTON ARRAYS

DEVICE PART NUMBER DESIGNATION

$V_{CE(MAX)}$	50 V	95 V
$I_{C(MAX)}$	500 mA	500 mA
Logic	Part Number	
5V TTL, CMOS	ULN2803A* ULN2803LW*	ULN2823A* ULN2823LW
6-15 V CMOS, PMOS	ULN2804A* ULN2804LW*	ULN2824A* ULN2824LW

*Also available for operation between -40°C and +85°C. To order, change prefix from 'ULN' to 'ULQ'.

**The ULx2804, ULx2823, & ULx2824 are last-time buy.
Orders accepted until October 19, 2001.**

PARTIAL SCHEMATICS

ULx28x3A/LW (Each Driver)

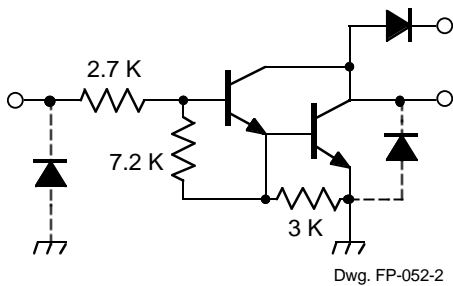

ULx28x4A/LW (Each Driver)

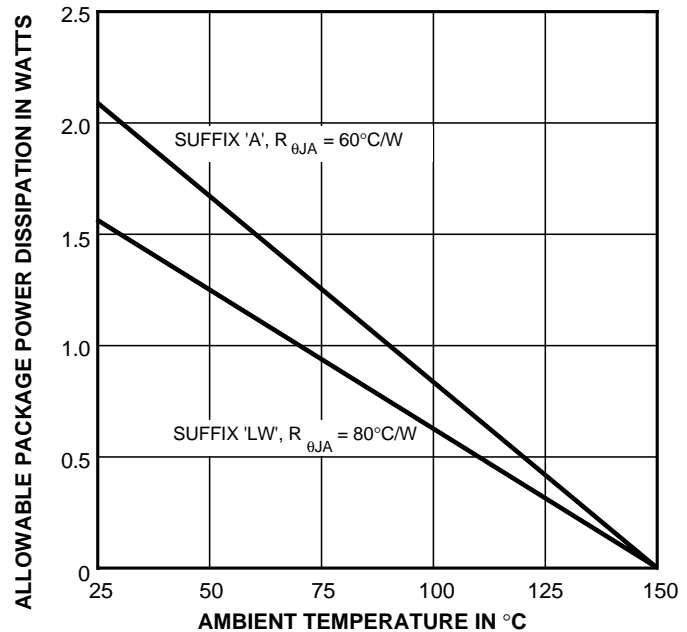
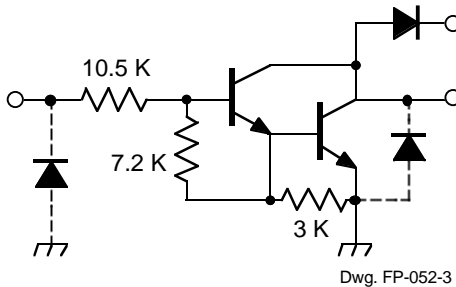

Dwg. GP-018B

x = Character to identify specific device. Specification shown applies to family of devices with remaining digits as shown. See matrix above.

**2803 THRU 2824
HIGH-VOLTAGE,
HIGH-CURRENT
DARLINGTON ARRAYS**

**Types ULx2803A, ULx2803LW, ULx2804A, and ULx2804LW
ELECTRICAL CHARACTERISTICS at +25°C (unless otherwise noted).**

Characteristic	Symbol	Test Fig.	Applicable Devices	Test Conditions	Limits			
					Min.	Typ.	Max.	Units
Output Leakage Current	I _{CEX}	1A	All	V _{CE} = 50 V, T _A = 25°C	—	< 1	50	μA
				V _{CE} = 50 V, T _A = 70°C	—	< 1	100	μA
		1B	ULx2804x	V _{CE} = 50 V, T _A = 70°C, V _{IN} = 1.0 V	—	< 5	500	μA
Collector-Emitter Saturation Voltage	V _{CE(SAT)}	2	All	I _C = 100 mA, I _B = 250 μA	—	0.9	1.1	V
				I _C = 200 mA, I _B = 350 μA	—	1.1	1.3	V
				I _C = 350 mA, I _B = 500 μA	—	1.3	1.6	V
Input Current	I _{IN(ON)}	3	ULx2803x	V _{IN} = 3.85 V	—	0.93	1.35	mA
			ULx2804x	V _{IN} = 5.0 V	—	0.35	0.5	mA
			ULx2804x	V _{IN} = 12 V	—	1.0	1.45	mA
	I _{IN(OFF)}	4	All	I _C = 500 μA, T _A = 70°C	50	65	—	μA
Input Voltage	V _{IN(ON)}	5	ULx2803x	V _{CE} = 2.0 V, I _C = 200 mA	—	—	2.4	V
				V _{CE} = 2.0 V, I _C = 250 mA	—	—	2.7	V
				V _{CE} = 2.0 V, I _C = 300 mA	—	—	3.0	V
			ULx2804x	V _{CE} = 2.0 V, I _C = 125 mA	—	—	5.0	V
				V _{CE} = 2.0 V, I _C = 200 mA	—	—	6.0	V
				V _{CE} = 2.0 V, I _C = 275 mA	—	—	7.0	V
				V _{CE} = 2.0 V, I _C = 350 mA	—	—	8.0	V
Input Capacitance	C _{IN}	—	All		—	15	25	pF
Turn-On Delay	t _{PLH}	8	All	0.5 E _{IN} to 0.5 E _{OUT}	—	0.25	1.0	μs
Turn-Off Delay	t _{PHL}	8	All	0.5 E _{IN} to 0.5 E _{OUT}	—	0.25	1.0	μs
Clamp Diode Leakage Current	I _R	6	All	V _R = 50 V, T _A = 25°C	—	—	50	μA
				V _R = 50 V, T _A = 70°C	—	—	100	μA
Clamp Diode Forward Voltage	V _F	7	All	I _F = 350 mA	—	1.7	2.0	V

Complete part number includes prefix to operating temperature range: ULN = -20°C to +85°C, ULQ = -40°C to +85°C and a suffix to identify package style: A = DIP, LW = SOIC.

**The ULx2804 is last-time buy.
Orders accepted until October 19, 2001.**

2803 THRU 2824 HIGH-VOLTAGE, HIGH-CURRENT DARLINGTON ARRAYS

Types ULx2823A, ULN2823LW, ULx2824A, and ULN2824LW ELECTRICAL CHARACTERISTICS at +25°C (unless otherwise noted).

Characteristic	Symbol	Test Fig.	Applicable Devices	Test Conditions	Limits			
					Min.	Typ.	Max.	Units
Output Leakage Current	I_{CEX}	1A	All	$V_{CE} = 95\text{ V}, T_A = 25^\circ\text{C}$	—	< 1	50	μA
				$V_{CE} = 95\text{ V}, T_A = 70^\circ\text{C}$	—	< 1	100	μA
		1B	ULx2824x	$V_{CE} = 95\text{ V}, T_A = 70^\circ\text{C}, V_{IN} = 1.0\text{ V}$	—	< 5	500	μA
Collector-Emitter Saturation Voltage	$V_{CE(SAT)}$	2	All	$I_C = 100\text{ mA}, I_B = 250\text{ }\mu\text{A}$	—	0.9	1.1	V
				$I_C = 200\text{ mA}, I_B = 350\text{ }\mu\text{A}$	—	1.1	1.3	V
				$I_C = 350\text{ mA}, I_B = 500\text{ }\mu\text{A}$	—	1.3	1.6	V
Input Current	$I_{IN(ON)}$	3	ULx2823x	$V_{IN} = 3.85\text{ V}$	—	0.93	1.35	mA
			ULx2824x	$V_{IN} = 5.0\text{ V}$	—	0.35	0.5	mA
				$V_{IN} = 12\text{ V}$	—	1.0	1.45	mA
	$I_{IN(OFF)}$	4	All	$I_C = 500\text{ }\mu\text{A}, T_A = 70^\circ\text{C}$	50	65	—	μA
Input Voltage	$V_{IN(ON)}$	5	ULx2823x	$V_{CE} = 2.0\text{ V}, I_C = 200\text{ mA}$	—	—	2.4	V
				$V_{CE} = 2.0\text{ V}, I_C = 250\text{ mA}$	—	—	2.7	V
				$V_{CE} = 2.0\text{ V}, I_C = 300\text{ mA}$	—	—	3.0	V
			ULx2824x	$V_{CE} = 2.0\text{ V}, I_C = 125\text{ mA}$	—	—	5.0	V
				$V_{CE} = 2.0\text{ V}, I_C = 200\text{ mA}$	—	—	6.0	V
				$V_{CE} = 2.0\text{ V}, I_C = 275\text{ mA}$	—	—	7.0	V
				$V_{CE} = 2.0\text{ V}, I_C = 350\text{ mA}$	—	—	8.0	V
Input Capacitance	C_{IN}	—	All		—	15	25	pF
Turn-On Delay	t_{PLH}	8	All	$0.5 E_{IN}$ to $0.5 E_{OUT}$	—	0.25	1.0	μs
Turn-Off Delay	t_{PHL}	8	All	$0.5 E_{IN}$ to $0.5 E_{OUT}$	—	0.25	1.0	μs
Clamp Diode Leakage Current	I_R	6	All	$V_R = 95\text{ V}, T_A = 25^\circ\text{C}$	—	—	50	μA
				$V_R = 95\text{ V}, T_A = 70^\circ\text{C}$	—	—	100	μA
Clamp Diode Forward Voltage	V_F	7	All	$I_F = 350\text{ mA}$	—	1.7	2.0	V

Complete part number includes prefix to operating temperature range: ULN = -20°C to +85°C, ULQ = -40°C to +85°C and a suffix to identify package style: A = DIP, LW = SOIC. Note that the ULQ2823LW and ULQ2824LW are not presently available.

**The ULx2823 & ULx2824 are last-time buy.
Orders accepted until October 19, 2001.**

2803 THRU 2824 HIGH-VOLTAGE, HIGH-CURRENT DARLINGTON ARRAYS

TEST FIGURES

FIGURE 1A

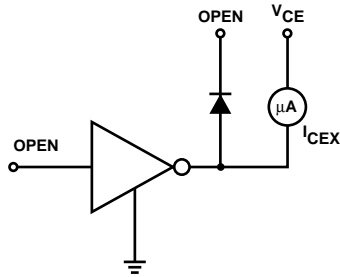

Dwg. No. A-9729A

FIGURE 1B

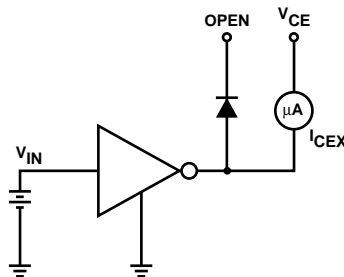

Dwg. No. A-9730A

FIGURE 2

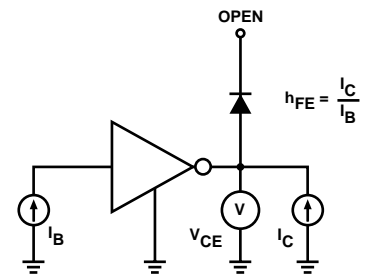

Dwg. No. A-9731A

FIGURE 3

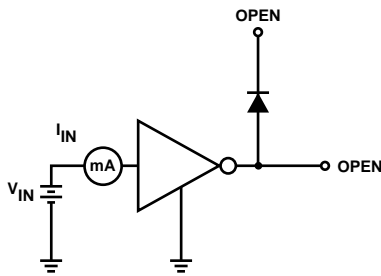

Dwg. No. A-9732A

FIGURE 4

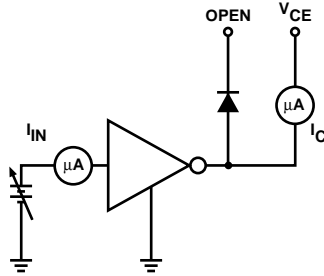

Dwg. No. A-9733A

FIGURE 5

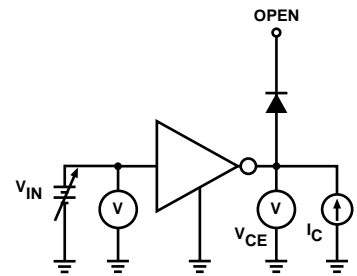

Dwg. No. A-9734A

FIGURE 6

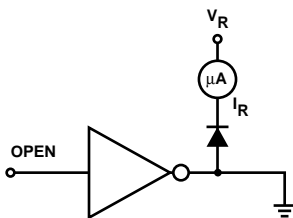

Dwg. No. A-9735A

FIGURE 7

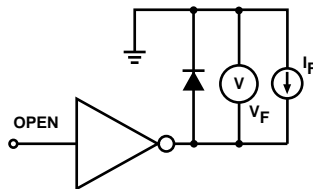

Dwg. No. A-9736A

FIGURE 8

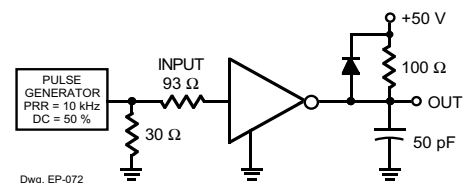

Dwg. EP-072

	V_{in}
ULx28x3x	3.5 V
ULx28x4x	12 V

2803 THRU 2824 HIGH-VOLTAGE, HIGH-CURRENT DARLINGTON ARRAYS

**ALLOWABLE COLLECTOR CURRENT
AS A FUNCTION OF DUTY CYCLE**
ULx28xxA

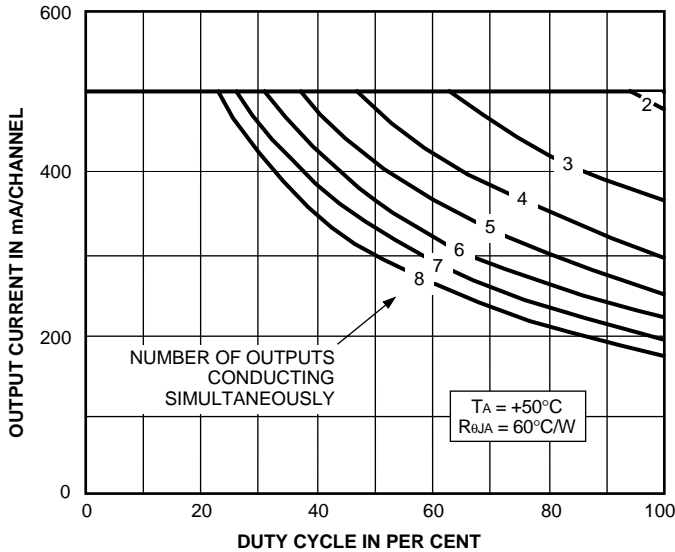

**ALLOWABLE COLLECTOR CURRENT
AS A FUNCTION OF DUTY CYCLE**
ULx28xxLW

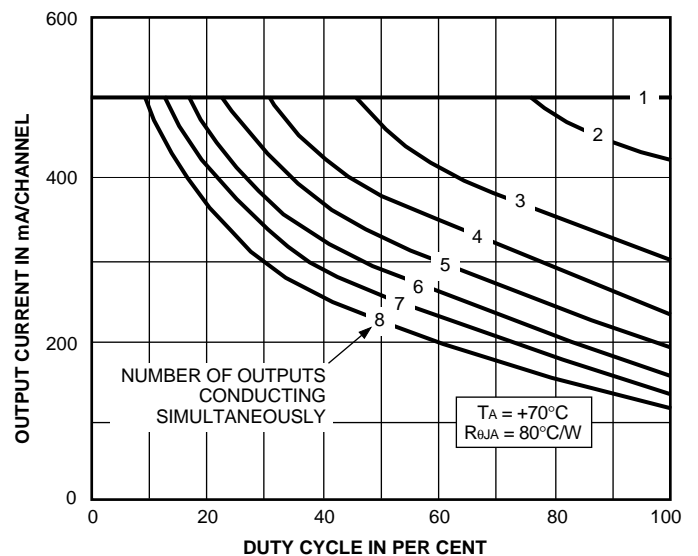
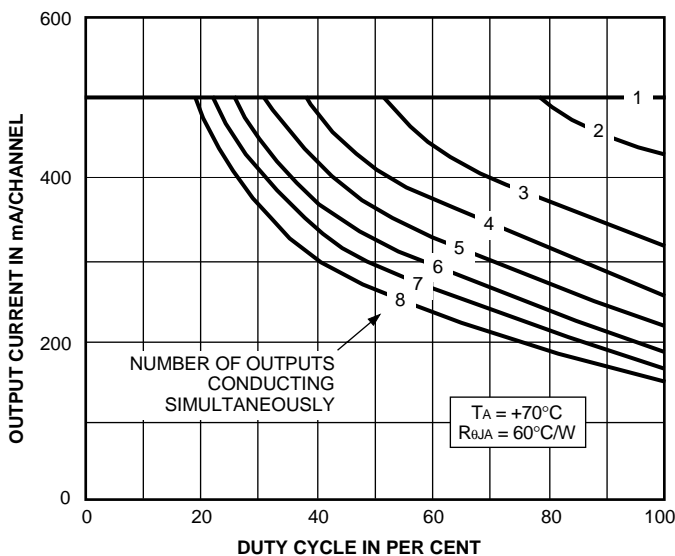
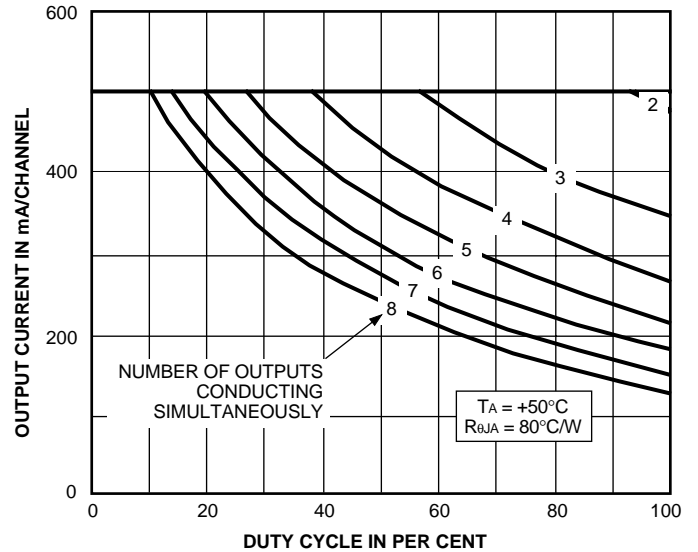

x = Characters to identify specific device. Specification shown applies to family of devices with remaining digits as shown.

2803 THRU 2824 HIGH-VOLTAGE, HIGH-CURRENT DARLINGTON ARRAYS

**INPUT CURRENT AS A
FUNCTION OF INPUT VOLTAGE**
ULx28x3x

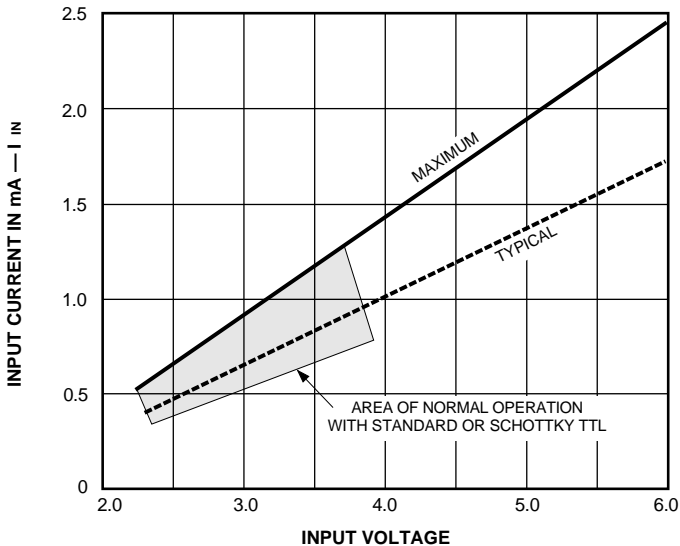

Dwg. GP-069

**SATURATION VOLTAGE AS A FUNCTION OF
COLLECTOR CURRENT**

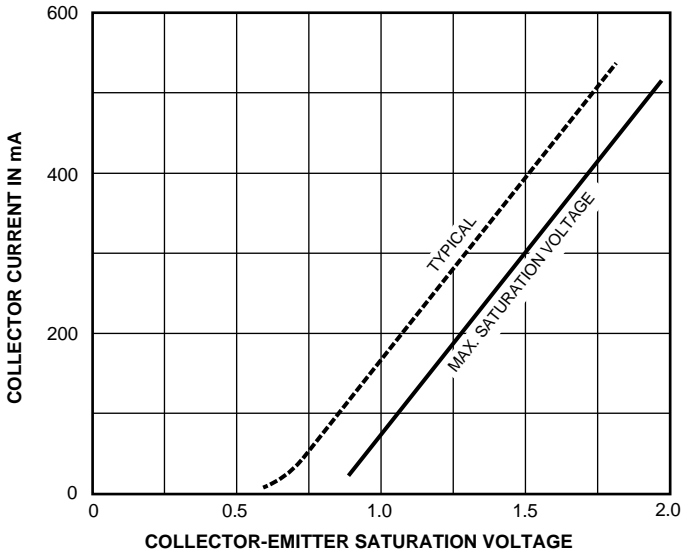

Dwg. GP-067

ULx28x4x

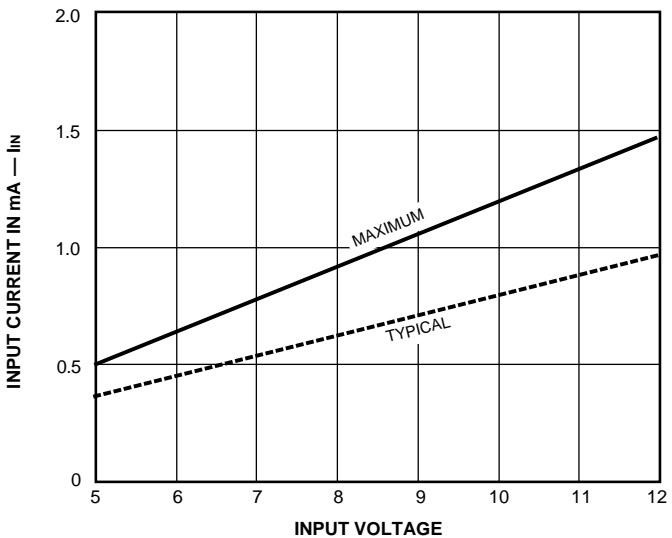

Dwg. GP-069-1

**COLLECTOR CURRENT AS A
FUNCTION OF INPUT CURRENT**

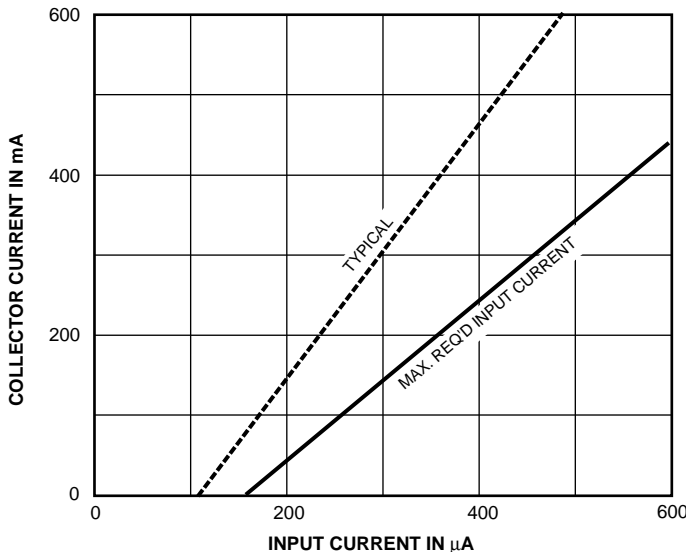

Dwg. GP-068

x = Characters to identify specific device. Characteristic shown applies to family of devices with remaining digits as shown.

**2803 THRU 2824
HIGH-VOLTAGE,
HIGH-CURRENT
DARLINGTON ARRAYS**

PACKAGE DESIGNATOR "A" DIMENSIONS

Dimensions in Inches
(controlling dimensions)

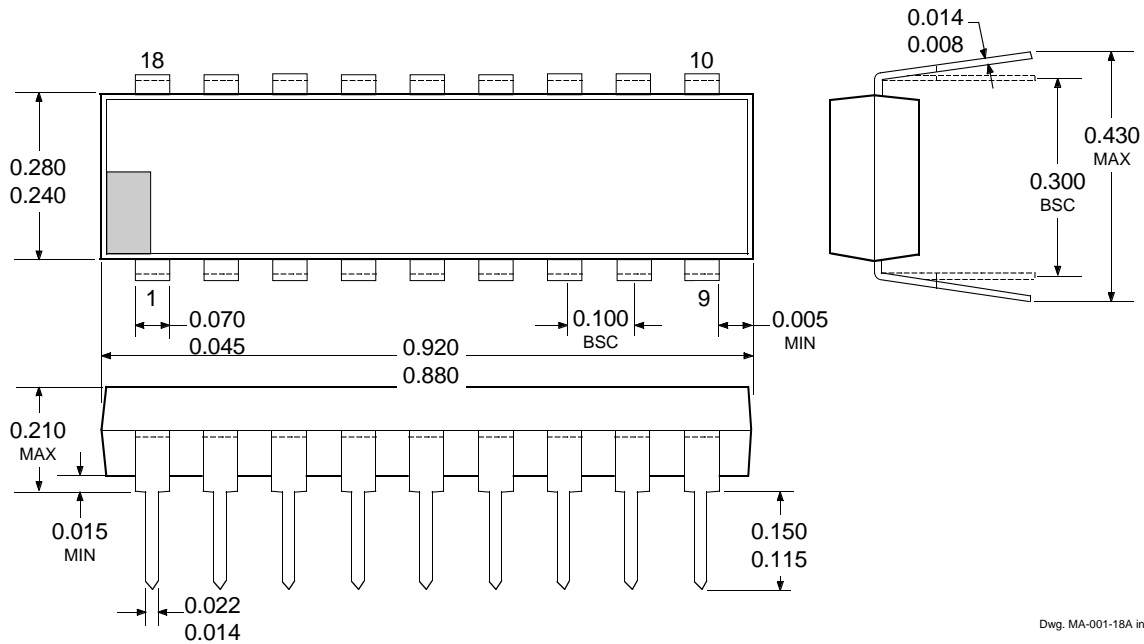

Dwg. MA-001-18A in

Dimensions in Millimeters
(for reference only)

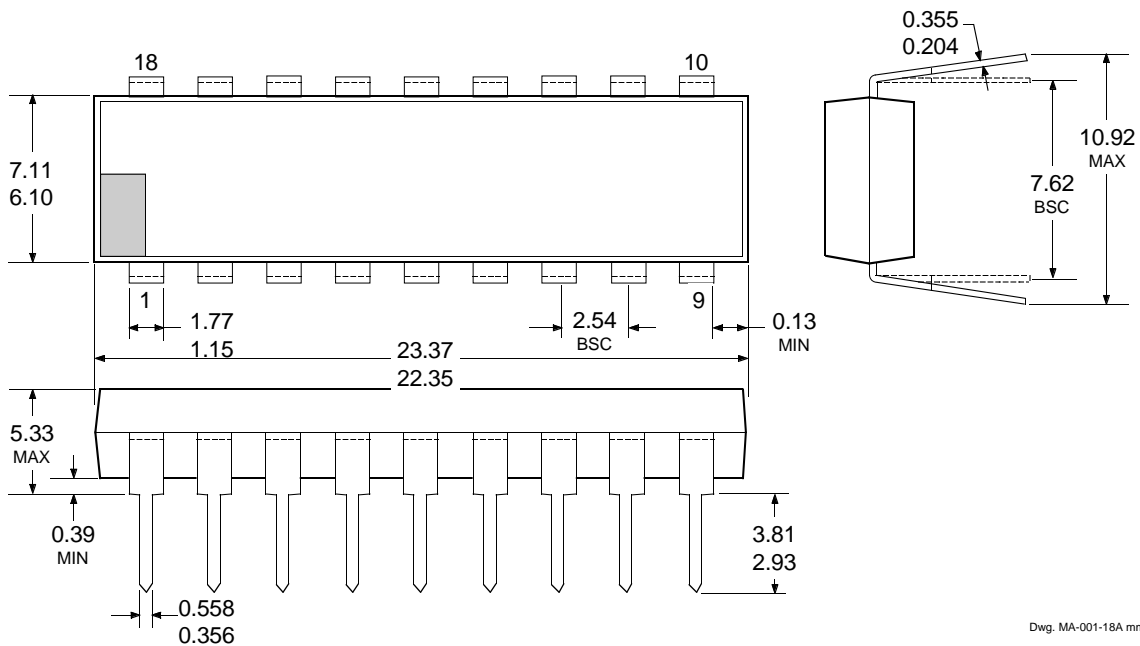

Dwg. MA-001-18A mm

- NOTES: 1. Exact body and lead configuration at vendor's option within limits shown.
2. Lead spacing tolerance is non-cumulative.
3. Lead thickness is measured at seating plane or below.

2803 THRU 2824 HIGH-VOLTAGE, HIGH-CURRENT DARLINGTON ARRAYS

PACKAGE DESIGNATOR "LW" DIMENSIONS

Dimensions in Inches
(for reference only)

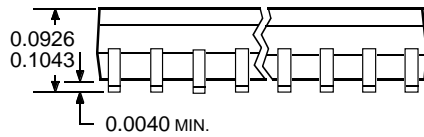
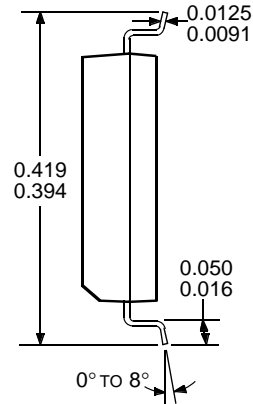
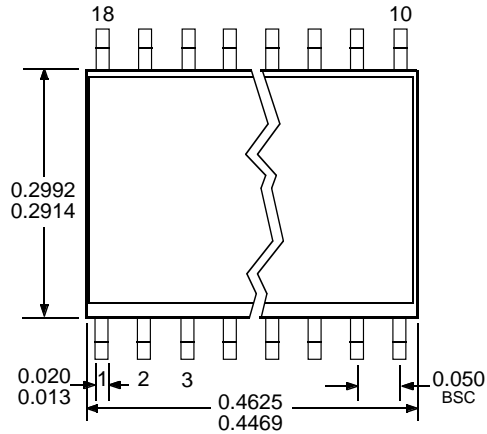

Dwg. MA-008-18A.in

Dimensions in Millimeters
(controlling dimensions)

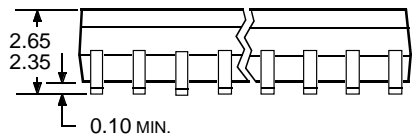
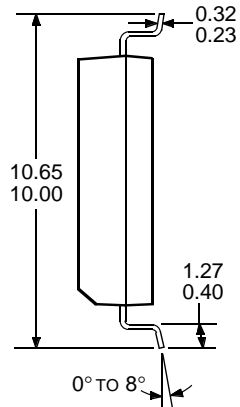
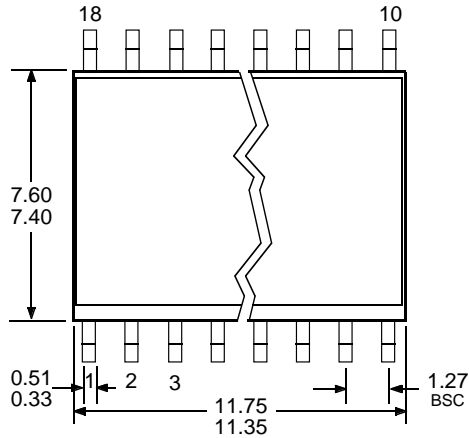

Dwg. MA-008-18A.mm

- NOTES: 1. Exact body and lead configuration at vendor's option within limits shown.
2. Lead spacing tolerance is non-cumulative.

**2803 THRU 2824
HIGH-VOLTAGE,
HIGH-CURRENT
DARLINGTON ARRAYS**

The products described here are manufactured under one or more U.S. patents or U.S. patents pending.

Allegro MicroSystems, Inc. reserves the right to make, from time to time, such departures from the detail specifications as may be required to permit improvements in the performance, reliability, or manufacturability of its products. Before placing an order, the user is cautioned to verify that the information being relied upon is current.

Allegro products are not authorized for use as critical components in life-support devices or systems without express written approval.

The information included herein is believed to be accurate and reliable. However, Allegro MicroSystems, Inc. assumes no responsibility for its use; nor for any infringement of patents or other rights of third parties which may result from its use.